

**PALMER
FIXTURE
COMPANY**

Hand Dryer

Automatic

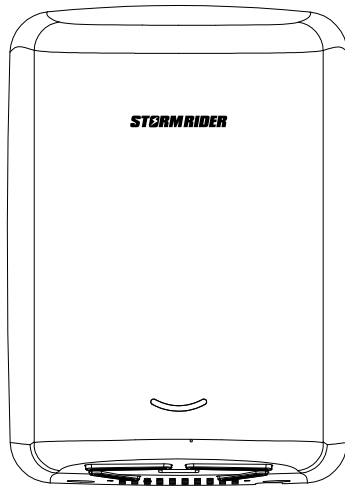

Palmer Fixture Company
P.O. Box 10887
Green Bay, WI 54307
1-800-558-8678
www.palmerfixture.com

Operating Instructions and Parts Manual (Automatic)

Surface Mount

Unit Size: (inch) mm

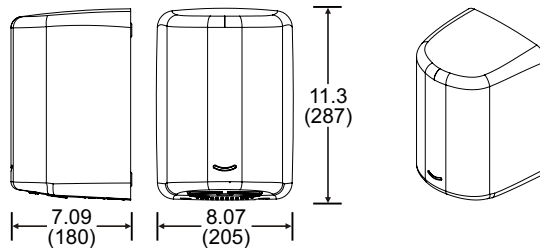

TECHNICAL SPECIFICATIONS

ITEM CATEGORY	PERFORMANCE DATA
Operating Voltage	HD-0960-17/27/09 110-120Vac, 50/60 Hz, 1.19-1.4 kW HD-0961-17/27/09 220-240Vac, 50/60 Hz, 1.19-1.4 kW
Warm Air Speed Output	145.4-212.5 mi/hr (65-95 m/s), adjustable
Air Output Temperature	131°F (55°C) – Ambient Temp. 77°F(25°C)
Dryer Shall Deliver	44.2-63.6 CFM (75-108 m³/h)
Motor Type	350-700W, 12000-18000 R.P.M., Adjustable; Brush Type, Dual Ball Bearings
Motor Thermal Protection	Auto Resetting Thermostat turns unit off, 120V at 275°F (135°C), 240V at 221°F (95°C)
Heater Element	450-700W, adjustable
Heater Thermal Protection	Auto Resetting Thermostat turns unit off at, 185°F (85°C), Thermal fuse cuts unit off at 288°F [142°C]
Drying Time	Less than 15 seconds
Circuit Operation	Infrared Automatic, self adjusting
Sensor Range	4" to 9" [100 mm to 230 mm], adjustable; standard 7" [18 cm ± 2 cm]
Timing Protection	60 seconds auto shut off
Drip proof	IP31
Isolation	CLASS 1
Net Weight	12.1 lbs (5.5 kgs)
Shipping Weight	13.4 lbs (6.1 kgs)
Unit Size	8.07" W x 11.3" H x 7.09" D [205 mm x 287 mm x 180 mm]

COVER TYPE/ COVER FINISH

HD-0960/0961-17 - Steel; White porcelain enameled coating. (t:1.6 mm)

HD-0960/0961-27 - Steel; Matte Black porcelain enameled coating. (t:1.6 mm)

HD-0960/0961-09 - Stainless Steel; Satin finish. (t:1.5 mm)

General safety information

⚠ WARNING This product is intended for installation by a qualified service person. Use 2.0 mm² (AWG NO.14) solid conductor for wiring.

⚠ DANGER Failure to properly ground unit could result in severe electrical shock and/or death.

⚠ WARNING Disconnect power at the service breaker before installing or servicing. Full pole disconnection device must be incorporated in the fixed wiring in accordance with the wiring rules.

⚠ WARNING All units must be supplied with a 3-wire service. The ground wire must be connected to the dryer's backplate.

NOTE: We do not recommend installing this dryer above a basin. If you are installing this dryer above a basin, please make sure that reflection won't occur.

[Type Y attachment]

If the power supply cord is damaged, it must be replaced by the manufacturer or its service agent or a qualified person in order to avoid a hazard. Disconnect the fixed wiring only in accordance with the wiring rules.

This appliance is not intended for use by persons (including children) with reduced physical, sensory or mental capabilities, or lack of experience and knowledge, unless they have been given supervision or instruction concerning use of the appliance by a person responsible for their safety.

Children should be supervised to ensure that they do not play with the appliance.

Circuit Diagram

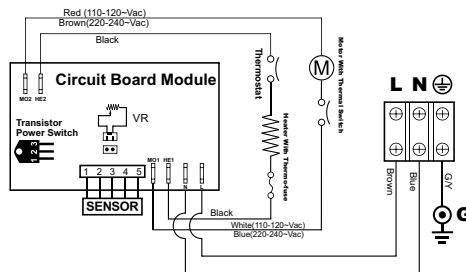

Installation

1. Make sure power supply breaker is switched off. Installation must be carried out in accordance with the current edition of the local wiring regulations code having jurisdiction. Installation should be performed only by a qualified electrician.
2. Place template against wall at desired height (see mounting height recommendations) and mark locations of 4 mounting holes and wire service entry at knockout (KO) location.

Note: For two or more dryers, dryers should be no closer than 24 inches (610 mm) on center.

1. Remove and retain 2 cover screws and cover.

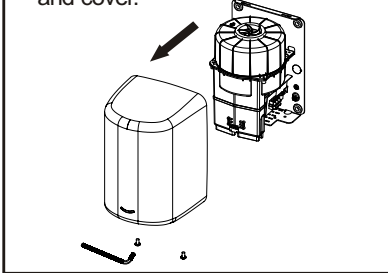

4. Fix the base plate to the wall with 4 screws of 1/4 x 1-1/2" dimension.

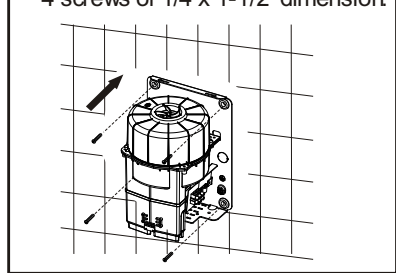

2. Insert the power cord into the opening.

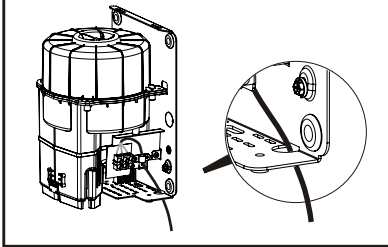

5. Put the front cover back and screw it with L key.

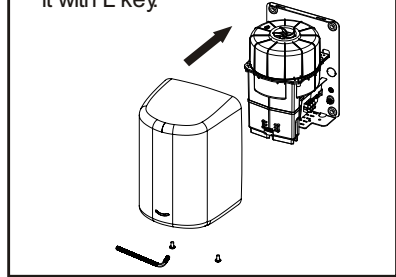

3. Connect supply wires to terminal block:

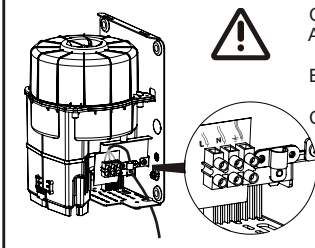

Connections:

- A. Connect the live wire (black or dark color) to the terminal block marked "L".
- B. Connect the neutral wire (white or light color) to the terminal block marked "N".
- C. Connect the ground wire (colored green or green and yellow) to the green screw marked "⊕".

Note that colors of live and neutral wires depend on voltage of supply service.

Recommended mounting heights

- from bottom edge of dryer above finished floor (AFF)

Men	1270 mm	(50")
Woman	1194 mm	(47")
Children 4-7 years	889 mm	(35")
Children 8-10 years	991 mm	(39")
Children 11-13 years	1092 mm	(43")
Children 14-16 years	1194 mm	(47")
Handicapped	1016 mm	(40")

Cleaning and Maintenance

Periodic cleaning of the unit is recommended to ensure optimum performance.

- Disconnect the electrical supply.
- Remove the two cover-mounting screws.
- Remove the cover.
- Clean all dust lint from the interior of the dryer.
- Do not flush with water.
- Wipe the cover with a damp cloth and mild cleaning solution. Do not Soak. Never use abrasives to clean the cover.
- Replace the cover. Do not over tighten the screws.



Warm air speed adjustment

1. Switch off the power, loosen the cover screws and remove the cover.
2. Use small Philips head screwdriver or plastic flat blade probe to turn VR shaft. Turn it gently clock-wise [CW] to increase power to maximum (+) ↻, [CCW] to reduce power as required (-) ↻.
3. Note that at minimum power the unit may not start if low line Voltage condition exists.

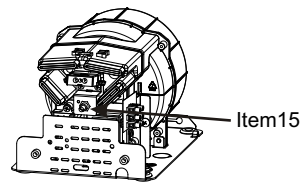

Sensor range adjustment

1. The ranger is 4" to 9" [100 mm to 230 mm], Standard 7" [180 mm ± 20 mm].
2. Clockwise: Lengthen the sensing range(+) ↻
3. Counterclockwise: Shorten the sensing range(-) ↻
4. DO NOT OVERTURN !

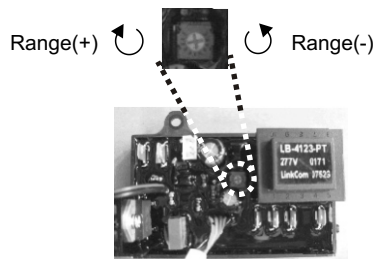

Diagnosics and Remedies

Symptom	Corrective Actions for Initial Installation Failures
If the dryer will not run	First ensure that the breaker supplying the dryer is operational. If it is, disconnect the power and remove the dryer cover. Taking suitable precautions to avoid shock hazard, reconnect the power and check for Voltage at the terminal block. Verify that connections are made correctly. Adjust the VR to make sure it is not set too low.
The dryer cycles by itself or runs constantly	Ensure that there is no obstruction on or in front of the IR sensor. Clean any dirt or debris off the sensor lens. If problem persists, replace sensor.
The dryer makes a loud Noise and does not run for a complete cycle	Ensure that the supply Voltage is correct. Dryer will make a loud humming noise if the input Voltage is too high. Verify Voltage requirement on unit rating label and correct supply as required. If CBM has been damaged, replace CBM, IR sensor module and VR component and cable.
The dryer runs but air stream is low pressure and/or low velocity	Ensure that the supply Voltage is correct. Dryer will run weakly if the input Voltage is too low. Verify Voltage requirement on unit rating label and correct supply as required.

Symptom	Corrective Actions for In-Service Failures
If the dryer will not run	First ensure that the breaker supplying the dryer is operational. If it is, disconnect the power and remove the dryer cover. Replace the CBM and IR sensor module. Test the VR for open circuit (see Technical Specifications for value). Replace VR if $\Omega = \infty$. Taking suitable precautions to avoid shock hazard, reconnect the power and check for Voltage at the terminal block.
The IR sensor only "sees" close range objects	Ensure that there is no obstruction on or in front of the IR sensor. Clean any dirt or debris off the sensor lens. If problem persists, disconnect the power and remove the dryer cover. Taking suitable precautions to avoid shock hazard, reconnect the power and try carefully adjusting the sensitivity control (yellow shaft in blue box on CBM) to increase the sensing range. If problem persists, replace sensor.
The heater gets hot but no air stream is produced	Disconnect the power. Remove the dryer cover and disassemble the blower-motor/fan housing. Replace the fan motor.
The dryer only blows cold air during a full cycle	Disconnect the power. Remove the dryer cover and disassemble the blower-motor/fan housing. Test the thermostat for open circuit. Check the heater element for signs of burning or breakage. Damaged element must be replaced.
The air stream is low pressure and velocity	Check the output nozzle for obstructions. If none are present, disconnect the power. Remove the dryer cover. Remove any dust/lint buildup from intake vent slots. Disassemble the blower-motor/fan housing. Check the motor brushes for worn condition ($\leq 25/64"$ [10 mm] graphite remains) and replace them, if necessary.

Diagram

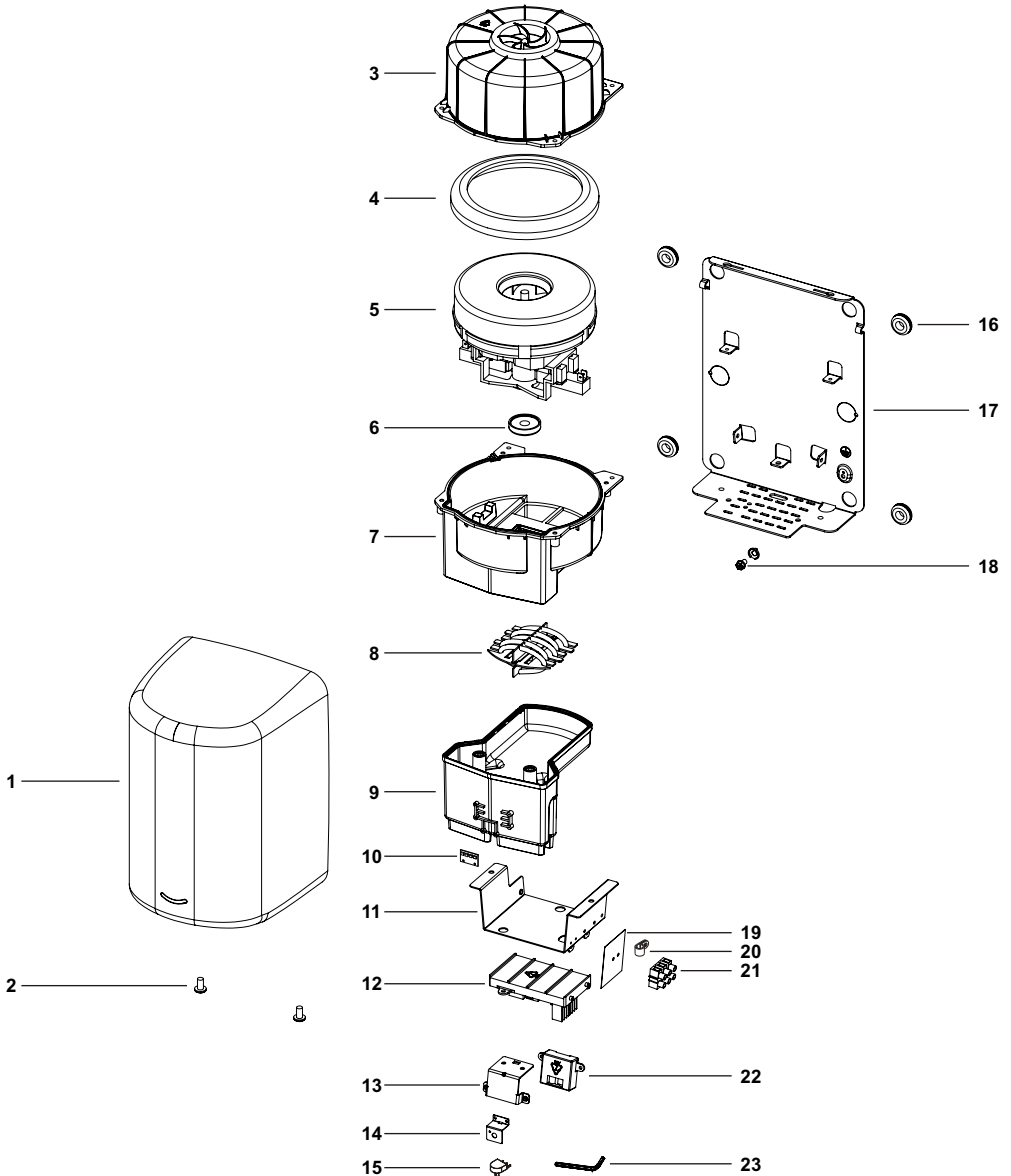

Repair parts list

Key	Description
1	Stainless Steel - Satin finish
2	Security hex screw (2 reqd.)
3	Blower housing - Top
4	Motor rubber - Large
5	Motor 110-120Vac 700W Motor 220-240Vac 700W
6	Motor rubber - Small
7	Blower housing - Bottom
8	Heater element 120Vac 700W Heater element 240Vac 700W
9	Air outlet
10	LED assembly
11	Air outlet bracket
12	Circuit Board Module 110-120Vac Circuit Board Module 220-240Vac
13	Sensor bracket
14	VR bracket
15	VR (variable resistance) 50K - 110-120Vac VR (variable resistance) 100K - 220-240Vac
16	Rubber grommet -Base (4 reqd.)
17	Base plate
18	Grounding screw
19	Insulation mylar
20	Cable clamp
21	Terminal block
22	Sensor Module
23	Security hex wrench