

PRODUCT SPECIFICATIONS

Elkay Wall Mount Heavy Duty Vandal Resistant ADA Cooler Filtered Refrigerated Stainless. Chilling Capacity of 8.0 GPH (gallons per hour) of 50° F drinking water, based on 80° F inlet water and 90° F ambient, per ASHRAE 18 testing. Features shall include Filtered, Heavy Duty Vandal Resistant. Furnished with Vandal Resistant StreamSaver™ bubbler. Mechanical Front Bubbler Button activation. Product shall be Wall Mount (On Wall), for Indoor applications, serving 1 station(s). Unit shall be certified to UL 399 and CAN/CSA C22.2 No. 120. Unit shall be lead-free design which is certified to NSF/ANSI 61 & 372 (lead free) and meets Federal and State low-lead requirements.



Special Features:	Filtered, Heavy Duty Vandal Resistant
Finish:	Stainless Steel
Power:	115V/60Hz
Bubbler Style:	Vandal Resistant StreamSaver™
Activation by:	Mechanical Front Bubbler Button
Mounting Type:	Wall Mount (On Wall)
Chilling Capacity*:	8.0 GPH
Full Load Amps	5
Rated Watts:	370
Dimensions (L x W x H):	18-3/16" x 18-9/16" x 20-7/16"
Approx. Shipping Weight:	76 lbs.
Installation Location:	Indoor
No. of Stations Served:	1
*Based on 80° F inlet water & 90° F ambient air temp for 50° F chilled drinking water.	

- Mechanically-Activated bubbler continues to supply water in event of service disruptions.
- Filter is certified to NSF 42 and 53 for lead, cyst, particulate, chlorine, taste and odor reduction. 1,500 gal. capacity.

COOLING SYSTEM

- Compressor: Hermetically-sealed, reciprocating type, single phase. Sealed-in lifetime lubrication.
- Condenser: Fan cooled, copper tube with aluminum fins. Fan motor is permanently lubricated.
- Cooling Unit: Combination tube-tank type. Continuous copper tubing with is fully insulated with EPS foam that meets UL requirements for self-extinguishing material.
- Refrigerant Control: Refrigerant R-134a is controlled by accurately calibrated capillary tube.
- Temperature Control: Easily accessible enclosed adjustable thermostat is factory preset. Requires no adjustment other than for altitude requirements.

Included with Product: Water Cooler, Filter

Ships in one box.

AMERICAN PRIDE. A LIFETIME TRADITION. Like your family, the Elkay family has values and traditions that endure. For almost a century, Elkay has been a family-owned and operated company, providing thousands of jobs that support our families and communities.



PRODUCT COMPLIANCE

- ADA & ICC A117.1
- ASME A112.19.3/CSA B45.4
- Buy American Act
- CAN/CSA C22.2 No. 120
- NSF/ANSI 42, 53, 61, & 372 (lead free)
- UL 399



Complies with ADA & ICC A117.1 accessibility requirements when installed according to the requirements outlined in these standards. Installation may require additional components and/or construction features to be fully compliant. Consult the local Authority Having Jurisdiction if necessary.

[Installation Instructions \(PDF\) - 98975C](#)

5 Year Limited Warranty on the refrigeration system of the unit. Electrical components and water system are warranted for 12 months from date of installation. **Warranty pertains to drinking water applications only. Non-drinking water applications are not covered under warranty.**

[Warranty \(PDF\)](#)

PART: _____ QTY: _____

PROJECT: _____





CONTACT: _____

DATE: _____

NOTES: _____

APPROVAL: _____

In keeping with our policy of continuing product improvement, Elkay reserves the right to change product specifications without notice. Please visit elkay.com for the most current version of Elkay product specification sheets. This specification describes an Elkay product with design, quality, and functional benefits to the user. When making a comparison of other producers' offerings, be certain these features are not overlooked.

Optional Accessories		
51299C	Elkay WaterSentry VII Replacement Filter (Coolers + Fountains) Spec Sheet (PDF)	
MLP100	In-wall Carrier for Single-station On-wall Bottle Fillers, Coolers & Fountains Spec Sheet (PDF)	
LKAPRVRCHD	Elkay Cane Apron for VRCHD Stainless Steel Spec Sheet (PDF)	
RP2130	Accessory - Wall Bezel Black Spec Sheet (PDF)	

In keeping with our policy of continuing product improvement, Elkay reserves the right to change product specifications without notice. Please visit elkay.com for the most current version of Elkay product specification sheets. This specification describes an Elkay product with design, quality, and functional benefits to the user. When making a comparison of other producers' offerings, be certain these features are not overlooked.

Open space rough-in design permits new installation or replacement of existing fountains and coolers with this Elkay cooler when rough-in is within the outline shown.

IMPORTANT! INSTALLER PLEASE NOTE:

This water cooler has been designed and built to provide water to the user which has not been altered by materials in the cooler waterways.

The grounding of electrical equipment such as telephone, computers, etc to water lines is a common procedure. This grounding may be in the building or occur away from the building. This grounding can cause electrical feedback into a water cooler creating an electrolysis which creates a metallic taste or causes an increase in the metal content of the water. This condition is avoidable by installing the cooler using the proper materials as shown below.

NOTICE

The water cooler must be connected to the water supply using a dielectric coupling. The cooler is furnished with a non-metallic strainer which meets this requirement. The drain trap which is provided by the installer should also be plastic to completely isolate the cooler from the building plumbing system.

OPERATION OF QUICK CONNECT FITTINGS

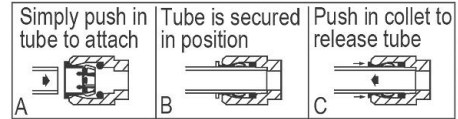

Pushing tube in before pulling it out helps to release tube

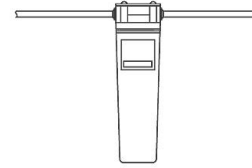

WaterSentry[®] VII Filter System

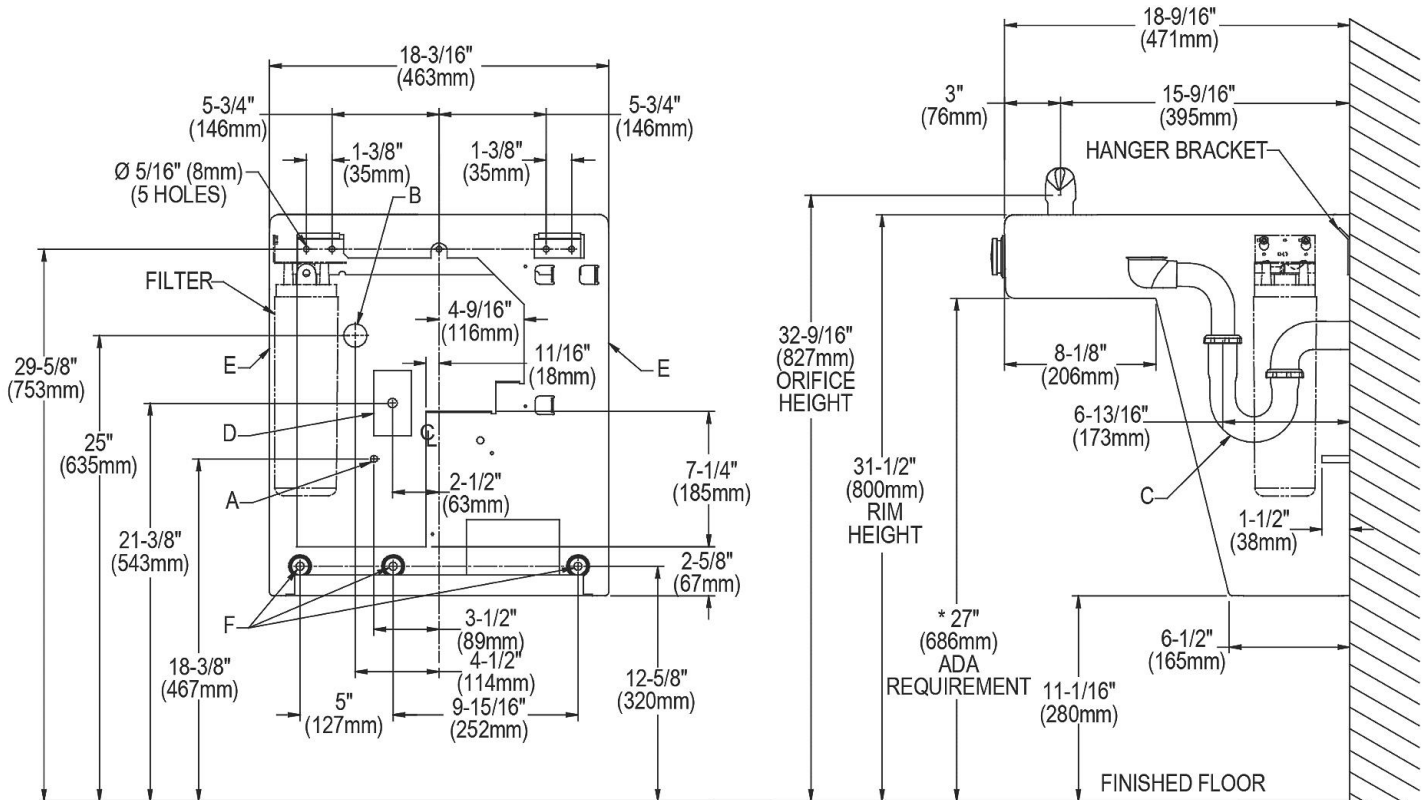

LEGEND

REDUCE HEIGHT BY 3" FOR INSTALLATION OF CHILDRENS ADA COOLER

- A = Recommended water supply location. Shut off valve (not furnished) to accept 3/8" O.D. unplated copper tube. 3" (76mm) maximum out from wall.
- B = Recommended location for waste outlet 1-1/4" O.D. drain.
- C = 1-1/4" Trap not furnished.
- D = Electrical supply (3) wire recessed box.
- E = Insure proper ventilation by maintaining 6" (152mm) (MIN.) clearance from cabinet louvers to wall.
- F = 7/16" Bolt holes for fastening unit to wall.

NOTE: New installations must use Ground Fault Circuit Interrupter (GFCI). It is highly recommended that the circuit be dedicated and the load protection be sized for 20 amps.

In keeping with our policy of continuing product improvement, Elkay reserves the right to change product specifications without notice. Please visit elkay.com for the most current version of Elkay product specification sheets. This specification describes an Elkay product with design, quality, and functional benefits to the user. When making a comparison of other producers' offerings, be certain these features are not overlooked.

Open space rough-in design permits new installation or replacement of existing fountains and coolers with this Elkay cooler when rough-in is within the outline shown.

IMPORTANT! INSTALLER PLEASE NOTE:

This water cooler has been designed and built to provide water to the user which has not been altered by materials in the cooler waterways.

The grounding of electrical equipment such as telephone, computers, etc to water lines is a common procedure. This grounding may be in the building or occur away from the building. This grounding can cause electrical feedback into a water cooler creating an electrolysis which creates a metallic taste or causes an increase in the metal content of the water. This condition is avoidable by installing the cooler using the proper materials as shown below.

NOTICE

The water cooler must be connected to the water supply using a dielectric coupling. The cooler is furnished with a non-metallic strainer which meets this requirement. The drain trap which is provided by the installer should also be plastic to completely isolate the cooler from the building plumbing system.

Simultaneous operation of both bubblers on a bi-level unit may not be possible depending on water supply pressure. If simultaneous operation is desired, please ensure a minimum of 65 psi supply. Lower pressure may be possible for non-filtered and/or non-refrigerated installations.

OPERATION OF QUICK CONNECT FITTINGS

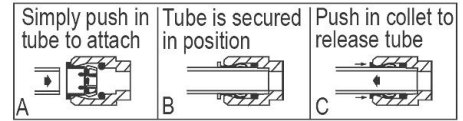

Pushing tube in before pulling it out helps to release tube

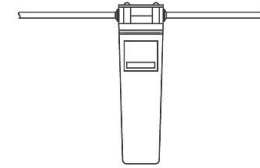

WaterSentry[®] VII Filter System

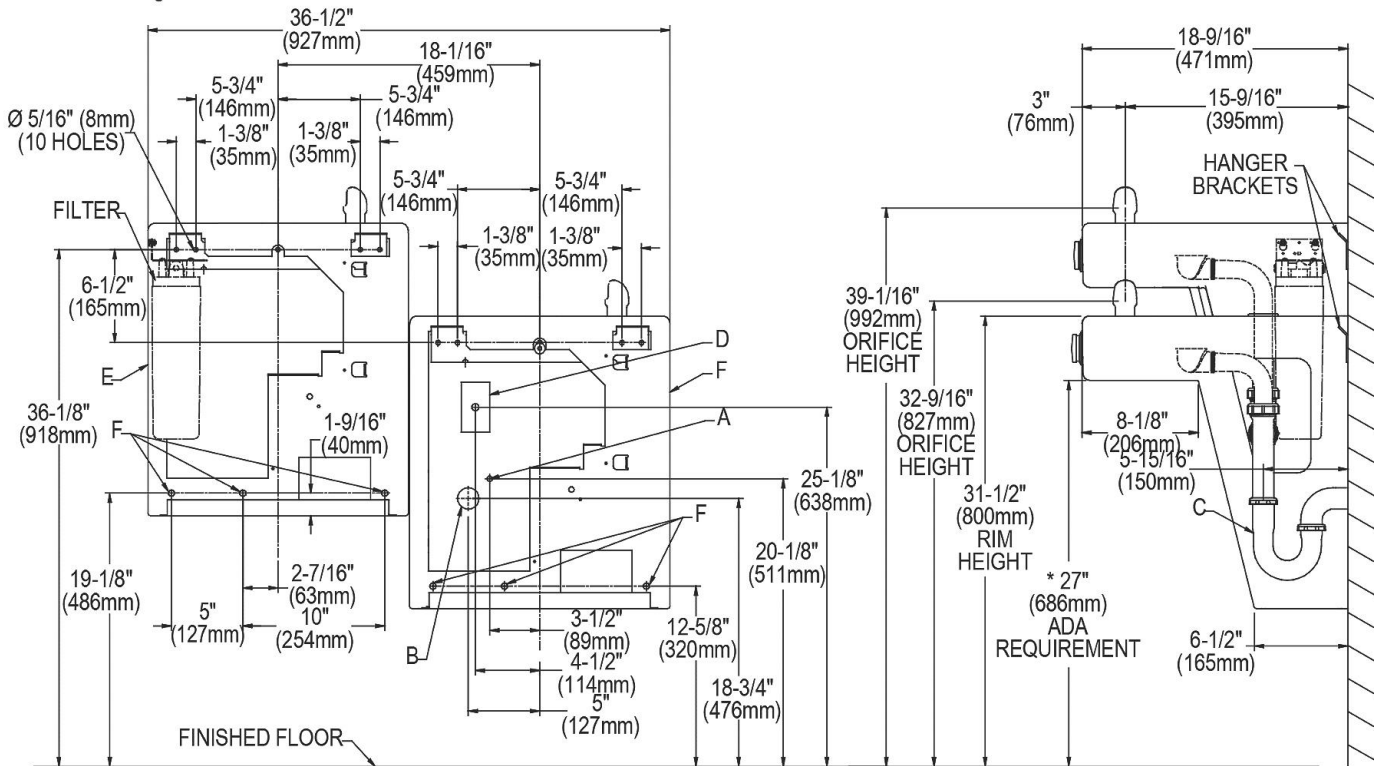

LEGEND

REDUCE HEIGHT BY 3 INCHES FOR INSTALLATION OF CHILDRENS ADA COOLER

A = Recommended water supply location. Shut off valve (not furnished) to accept 3/8" O.D. unplated copper tube. 3" (76mm) maximum out from wall.

B = Recommended location for waste outlet 1-1/2" O.D. drain. Drain stub 2" (51mm) out from wall.

C = 1-1/2" Trap not furnished.

D = Electrical supply (3) wire recessed box.

E = Insure proper ventilation by maintaining 6" (152mm) (MIN.) clearance from cabinet louvers to wall.

F = 7/16" Bolt holes for fastening unit to wall.

NOTE: New installations must use Ground Fault Circuit Interrupter (GFCI). It is highly recommended that the circuit be dedicated and the load protection be sized for 20 amps.

In keeping with our policy of continuing product improvement, Elkay reserves the right to change product specifications without notice. Please visit elkay.com for the most current version of Elkay product specification sheets. This specification describes an Elkay product with design, quality, and functional benefits to the user. When making a comparison of other producers' offerings, be certain these features are not overlooked.